

AUTO-*BLIP*

INTELLIGENT DOWNSHIFTS

www.AUTO-BLiP.com

User Manual Porsche 981/991

Version 1.8

WARNING:

Adjusting the settings of AUTO-BLiP while driving could lead to an accident and/or serious injuries. Changes should only be made when it is safe to do so. The primary attention of the driver should always be on safe driving. As with any gauge or instrumentation system in the vehicle, any information provided by Auto-Blip should be interacted with as part of a normal process of driving safely. **Auto-Blip is intended for racing and/or off-road use only!**

The mounting of AUTO-BLiP and the routing of the cable harness connecting it to the vehicle should be done with caution. This includes but is not limited to the following restrictions:

- Do Not mount the AUTO-BLiP where it can obstruct the view of the driver
- Do Not mount the AUTO-BLiP in a manner that could cause it to be propelled through the vehicle during an accident causing injury, such as over or near an air bag
- Do Not route the cable in a manner that would interfere with the operation of the vehicle controls

INTRODUCTION:

Congratulations on your purchase of AUTO-BLiP. Please take the time to read the entire instruction manual before attempting to install. **DO NOT** attempt the use of AUTO-BLiP until you have completed the entire installation process and the unit has been properly **calibrated**.

WE STRONGLY RECOMMEND THAT AN EXPERIENCED TECHNICIAN INSTALL AUTO-BLiP!

Tools (not all may be necessary depending on type of instal):

- Needle nose pliers
- Light (Forehead mounted recommended)
- Wire cutters / strippers - optional
- Digital Multimeter (DMM) - optional
- X-Acto knife or equivalent - optional

CONNECTIONS (IGNITION MUST BE OFF DURING INSTALLATION!):

1) When performing this installation, make sure the wire harness is securely routed away from any moving parts! If possible, secure the Auto-Blip harness to the car manufacturer's harness for added safety.

2) Some vehicle are equipped with two switches at the clutch pedal. The Cruise Control Disable switch is mounted higher up under the dashboard. The Safety Interlock switch is down lower on the pedal where it is visible. For this installation, you will only be working with the clutch Safety Interlock switch.

3) Soldering the Auto-Blip harness wires (6) to the respective car wires provides for the best results. However, due to the challenge of working under the dash, this should only be done by a professional. Auto-Blip now provides **Posi-tap connectors** as an alternative to soldering. **Follow the separate instructions available at www.auto-blip.com/support-center/** for best results.



Attention: AUTO-BLiP will not work until you complete the CALIBRATION PROCESS on page 11/12

Attention: Always connect the Posi- tap to the car wire first, then attach the AB wire

General overview of installation taps (Ignition must be off during installation!)

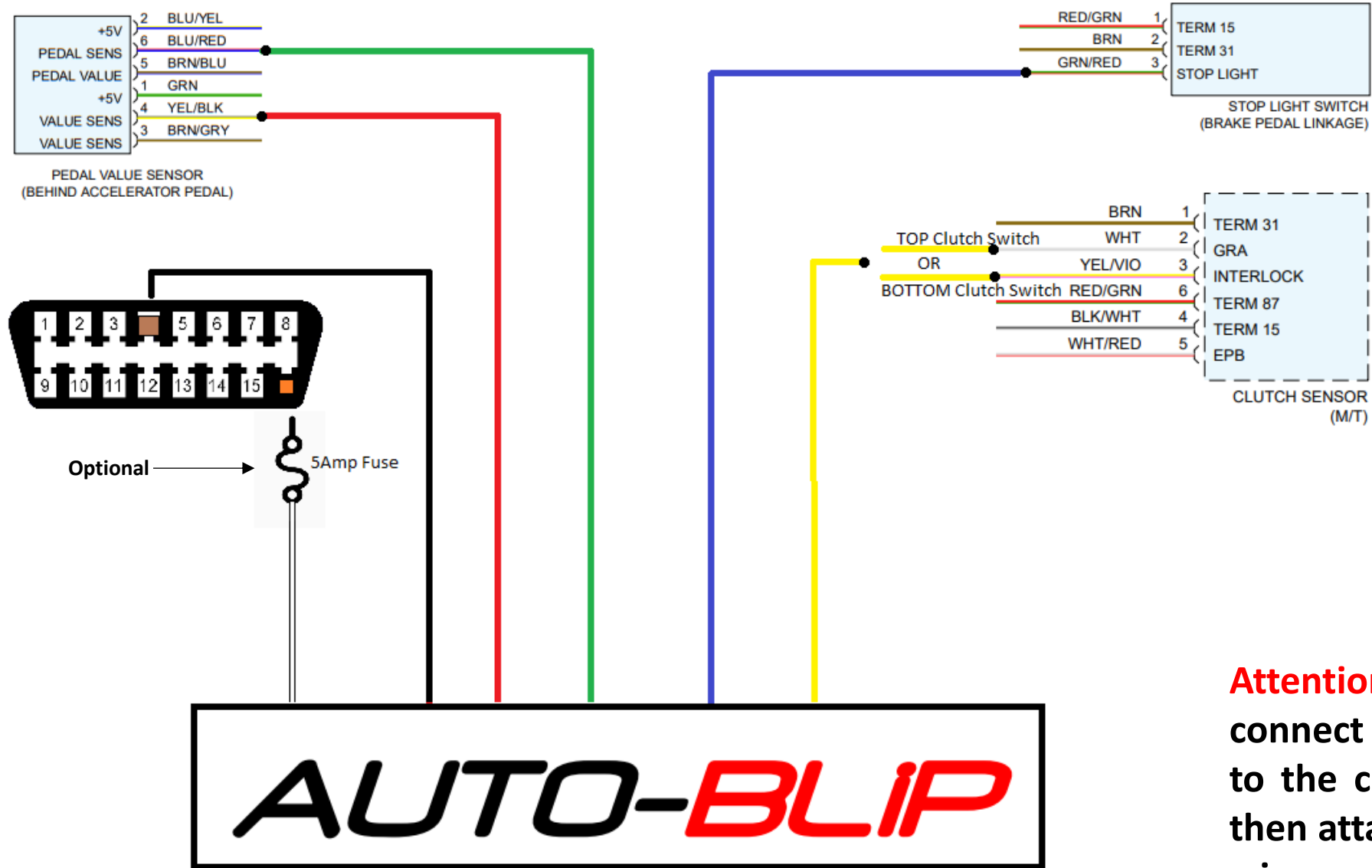

AUTO-BLIP

2013+ Porsche 911 (991-F6 3.8L)

Attention: Always connect the Posi-tap to the car wire first, then attach the AB wire

Connections (IGNITION MUST BE OFF DURING INSTALLATION!):

OBD2 port - 12v power and ground connections

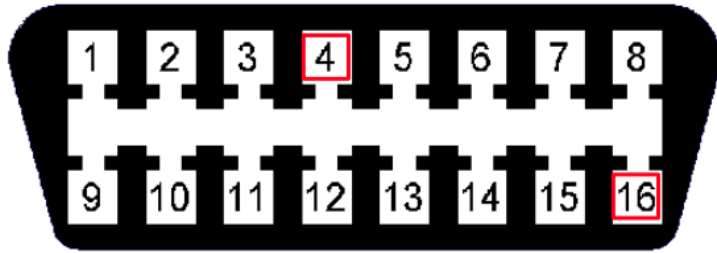

- Connect Auto-Blip White wire to pin 16 for 12v
- Connect Auto-Blip Black wire to pin 4 for Ground



Panel located on driver side footwell

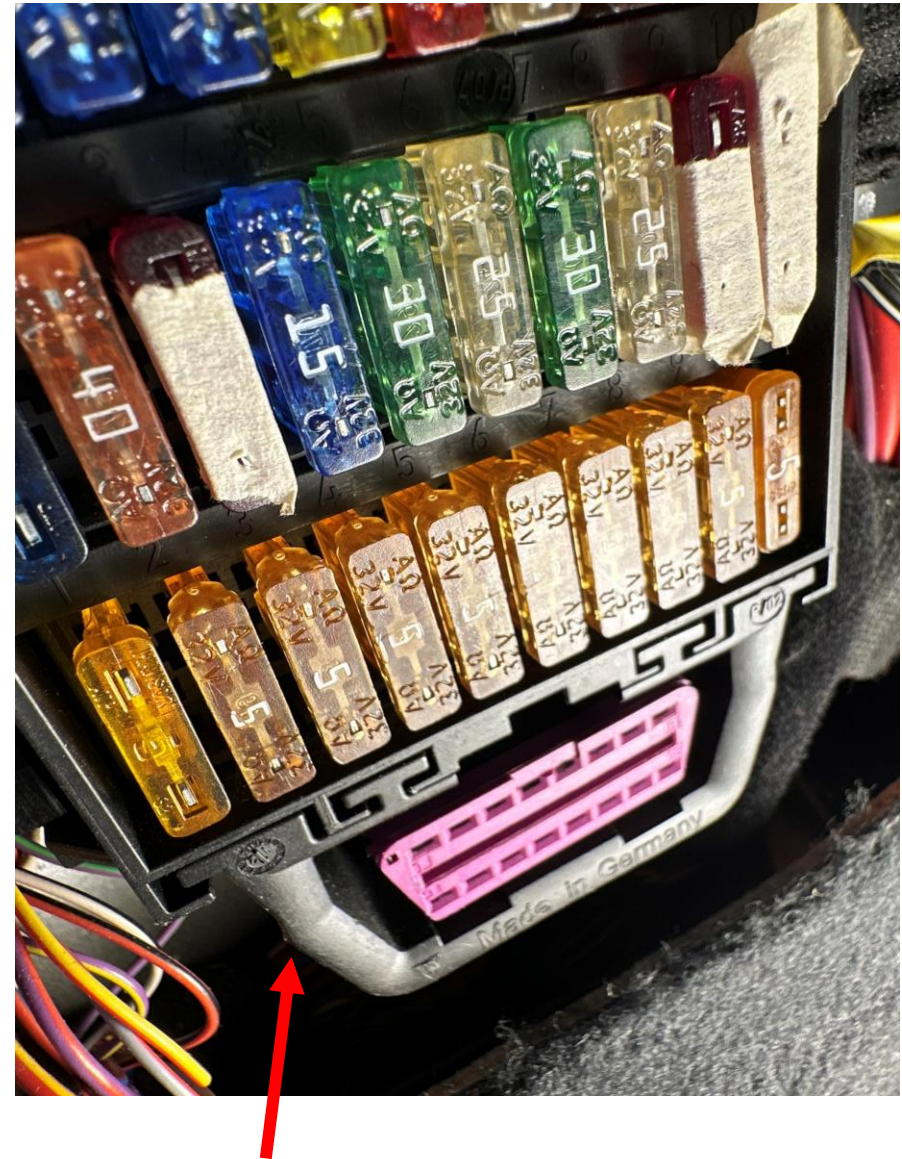

Slide out bottom tray holding OBD2 port in place, this will allow you to access wires from the back

Accelerator pedal – The wire position is numerically assigned in diagram (see number 1-6 to the left of color description). Remove torx screw to the left of the accelerator pedal for easy access to wires. Once screw is removed, pull the entire housing out and up until loose.

- Connect AB Green wire to Porsche **Blue/Red** wire at the accelerator pedal sensor (wire position #6)
- Connect AB Red wire to Porsche **Yellow/Black** wire at the accelerator pedal sensor (wire position #4)

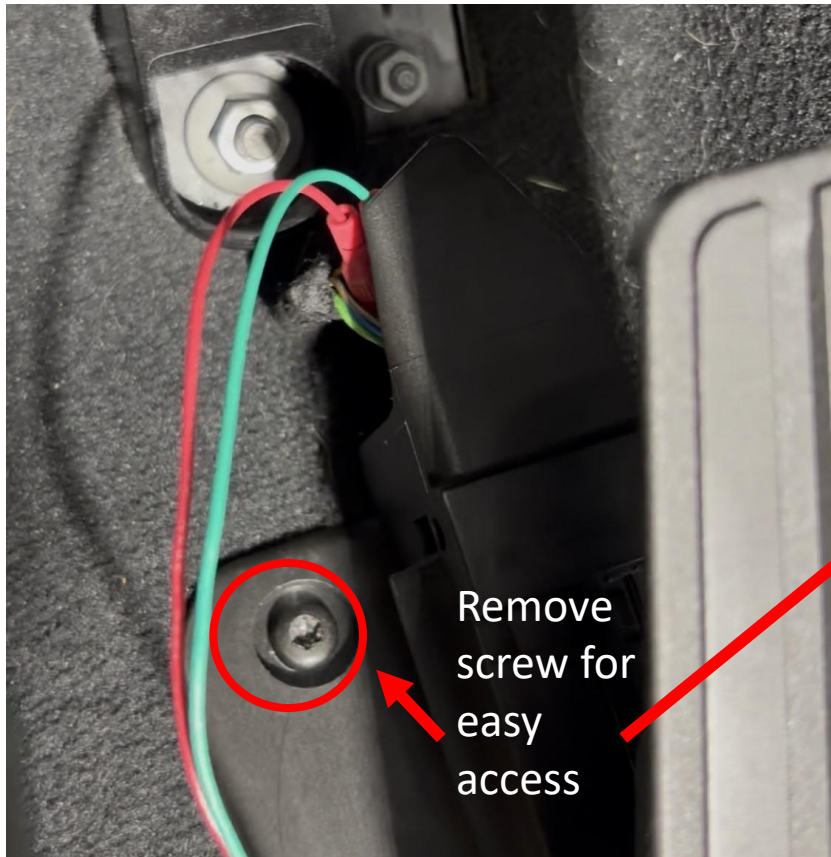
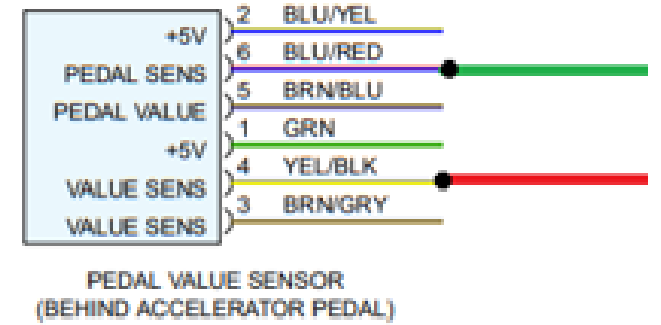

Brake pedal switch – Connect AB Blue wire to Porsche Green/Red wire. The break pedal has the switch concealed behind/below. You should be able to detach the switch in order to facilitate installing the connector/tap.

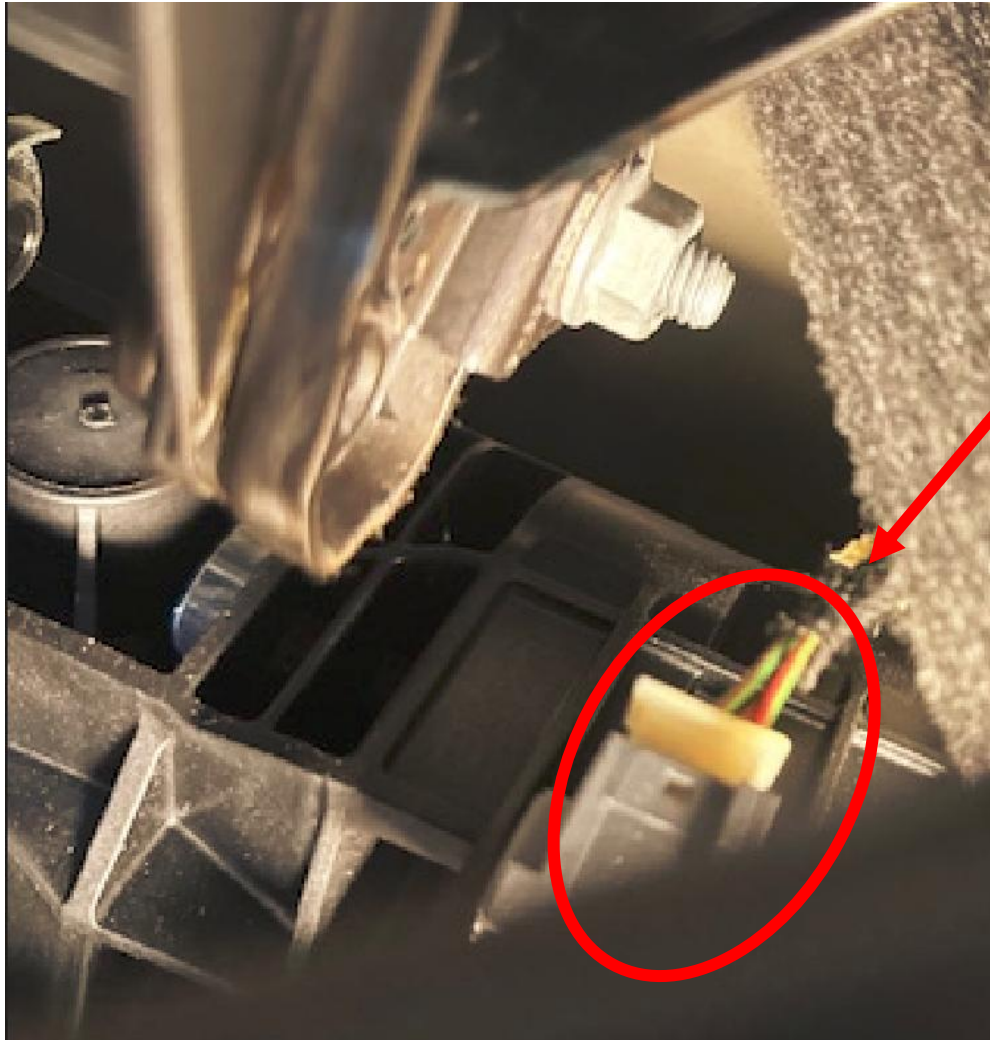
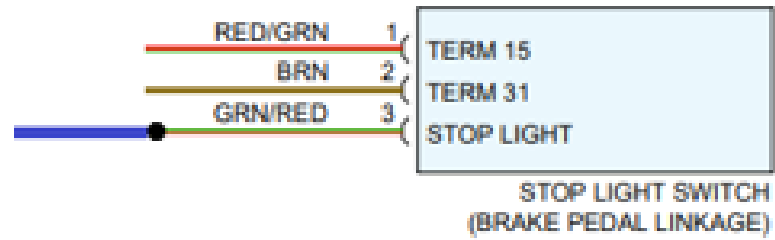

Brake switch



Caution!

The correct brake wire is **Green with a red stripe**. Do not confuse with the other wire which is Red with a green stripe also located at same switch

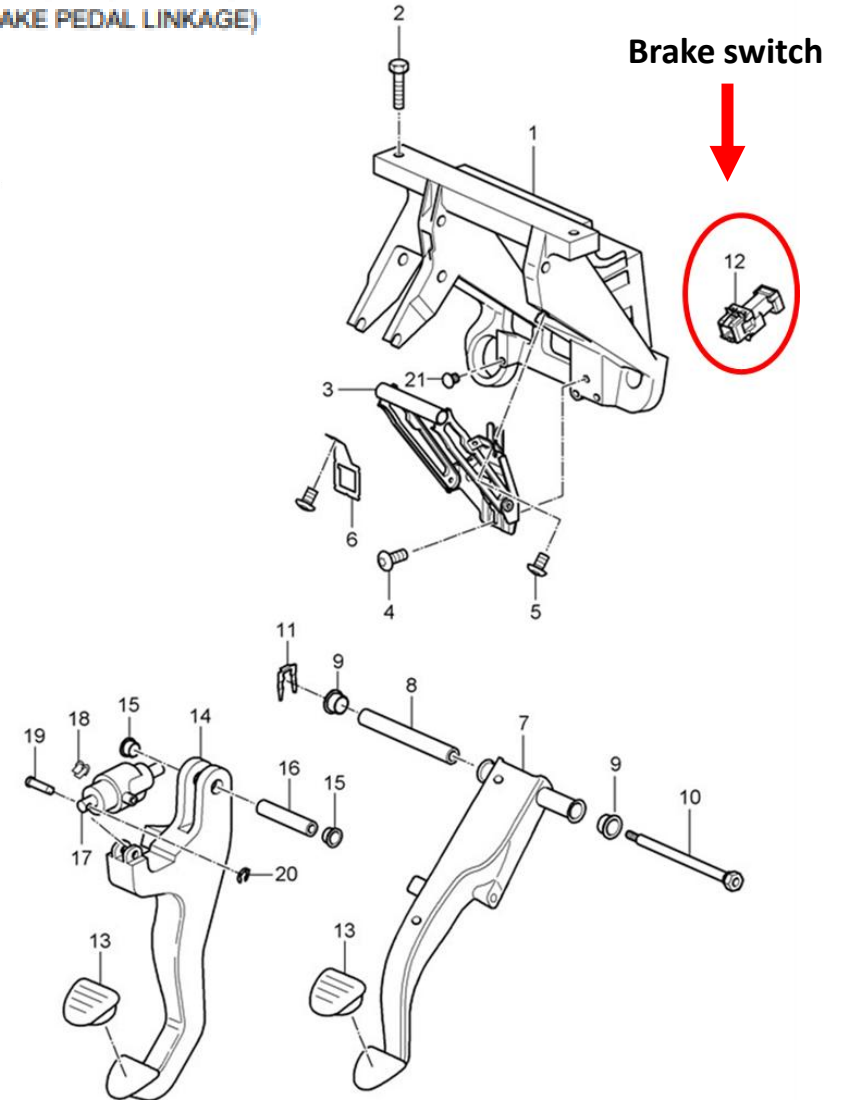

Break Pedal switch alternative placement:

As an alternative, you can tap on the Green with Red stripe break pedal wire at the point where the wire splits from the harness on the way to the brake pedal. This wire is coming/going to the 'frunk' via the firewall.

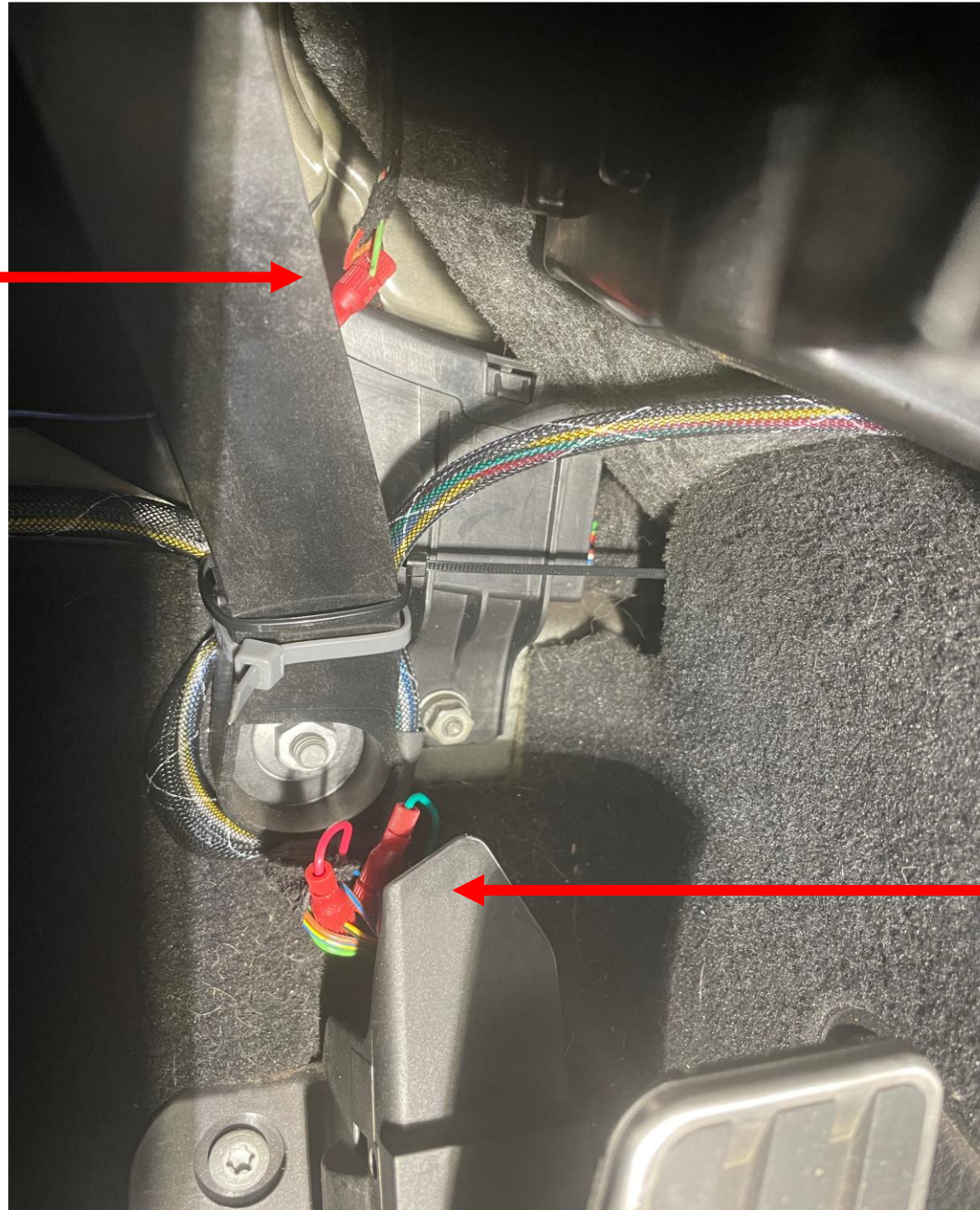
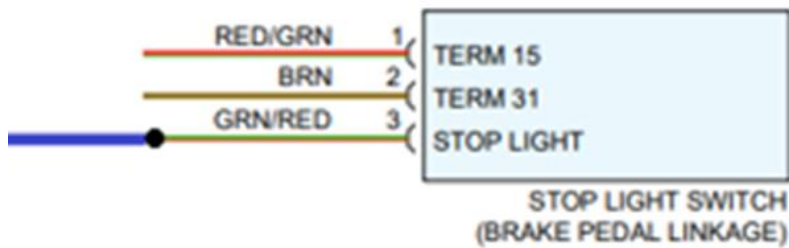

Accelerator pedal wire taps for Auto-Blip's Red and Green wires

Clutch pedal switch:

Connect AB yellow wire to Porsche Yellow/Violet wire coming through the firewall from the 'frunk'. The actual switch is only accessible from the 'frunk', this wire is coming back from that general direction.

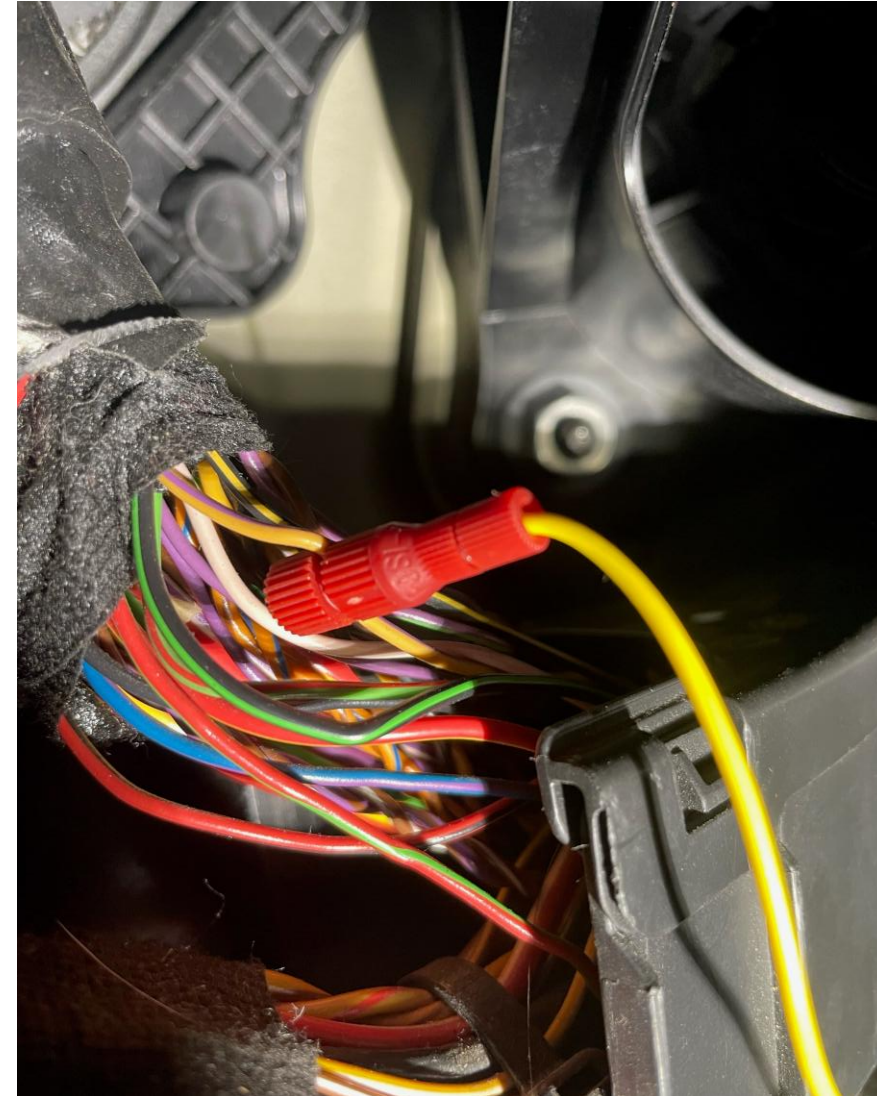
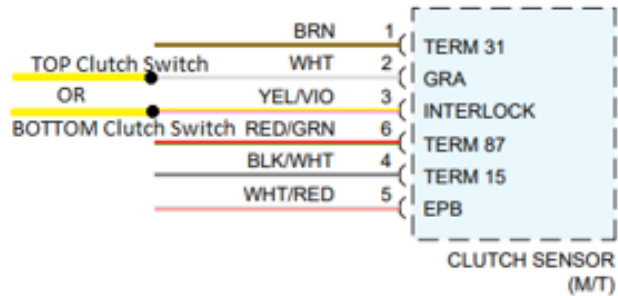

Attention: AUTO-BLiP will not work until you complete the CALIBRATION PROCESS on page 11/12

How it works:



1. The "DURATION" dial sets the desirable RPM blip level by opening the throttle. Turn dial clockwise to increase RPM blip level.
2. The "DELAY" dial allows for the insertion of a constant time delay from the time a downshift event is sensed to when the unit blips the throttle. Turn dial clockwise to increase delay. Range from 0 to 0.5 seconds.
3. The ON/OFF button will toggle between the ON and OFF mode. The unit will default to the ON state upon power up.
Note: This button is also use to enable the calibration mode. Refer to the Calibrating Unit section below for more details.
4. The "STATUS" LED turns on when the unit is ON.
5. The "BRAKE" LED turns on when the brake pedal is pressed.
6. The "CLUTCH" LED turns on when the clutch pedal is pressed.
7. The "BLIP" LED turns on when a throttle blip event occurs.

Note: The *AUTO-BLIP* will automatically turn OFF after 6 hours of inactivity. It will remain OFF until the ON/OFF button is pressed or power to the unit is removed and re-applied.

The *AUTO-BLIP* monitors your automobile's accelerator pedal, brake pedal, and clutch pedal, blipping the throttle only when the clutch pedal is being depressed while simultaneously braking.

Calibration process

In order for your *AUTO-BLiP* unit to function properly, you must first perform the calibration sequence outlined in this section!!!

1. Turn on ignition, but do not start engine. *AUTO-BLiP* "STATUS" LED light will light up (disregard all other LEDs at this point). If not, turn ignition off and verify the 12v supply and ground connectors are fully seated.
2. Set both the "DURATION" and "DELAY" adjusting dials on the *AUTO-BLiP* unit **completely counter clockwise (-)**.
3. To enter the calibration mode, press and hold down the ON/OFF button (about **10** seconds) until the "STATUS" LED continuously blinks **(1)** time followed by a short pause.
4. Fully press and hold down the accelerator pedal. While holding the accelerator pedal wide open, press and release the ON/OFF button once, continue to hold the accelerator pedal down. This step records your vehicle's full open throttle pedal position.
5. At this point the "STATUS" LED light will blink **(2)** times followed by a short pause. Completely release the accelerator pedal. With the accelerator pedal completely released, press and release the ON/OFF button once. This step records your vehicle's close throttle pedal position.
6. At this point the "STATUS" LED light will blink **(3)** times followed by a short pause. Completely press the brake pedal. With the brake pedal completely pressed, press and release the ON/OFF button once, continue to hold the brake pedal down. This step records your vehicle's brake pedal pressed position.
7. At this point the "STATUS" LED light will blink **(4)** times followed by a short pause. Completely release the brake pedal. With the brake pedal completely released, press and release the ON/OFF button once. This step records your vehicle's brake pedal released position.
8. At this point the "STATUS" LED light will blink **(5)** times followed by a short pause. Completely press the clutch pedal. With the clutch pedal completely pressed, press and release the ON/OFF button once, continue to hold the clutch pedal down. This step records your vehicle's clutch pedal pressed position.
9. At this point the "STATUS" LED light will blink **(6)** times followed by a short pause. Completely release the clutch pedal. With the clutch pedal completely released, press and release the ON/OFF button once. This step records your vehicle's clutch pedal released position.
10. This completes calibration of the *AUTO-BLiP* unit!

Calibration process

Note: When properly calibrated, the “BRAKE” and “CLUTCH” LEDs will turn on when the corresponding pedal is pressed.

Note: Calibration values will be retained in memory even if there is a break in the power supply.

The AUTO-BLiP features a diagnostic function that will warn the user when the AUTO-BLiP’s calibration routine fails to properly recognize the accelerator pedal position sensor (APPS), BRAKE, and/or CLUTCH signals. Failures related to the BRAKE and/or CLUTCH will prevent the unit from exiting the calibration sequence. This is done to prevent AUTO-BLiP from blipping the throttle at the incorrect time. When a failure is detected the AUTO-BLiP will continuously blink the “BRAKE”, “CLUTCH”, and/or “BLIP” LEDs, signaling a failure during calibration of the respective signals. Press and release the ON/OFF button once to re-start the calibration sequence from the beginning.

TECH SUPPORT

In the event of a malfunction, please check the following:

1. Turn off ignition then verify all connectors are fully seated.
2. Make sure the unit is properly powered. When unit is properly powered the “STATUS” LED will remain continuously lit.
3. Be sure the unit has been calibrated, as outlined in the calibration section, according to your vehicle’s model and year.
4. Check harness for cuts, scrapes or abrasions.
5. Technical support: call (713)289-4015 (Mon-Fri from 9A-3P CST); email al@auto-blip.com

Auto-Blip Limited Warranty

Tractive Technology, LLC warrants this product against defects in material and workmanship for the period of 90 days. The warranty period begins with the date of original retail purchase.

This limited warranty is made only to the original end user purchaser ("you") of the product and does not extend to any subsequent purchasers or owners of the product. The "original end user" is the first user to put the product into service in any fashion. It is your responsibility to establish the warranty period by verifying the original purchase date.

If you discover a defect, Tractive Technology, LLC will, at its option, repair or replace this product with a new or reconditioned product at no charge to you, provided you return it during the warranty period, with transportation charges prepaid, to Tractive Technology, LLC. (You can obtain additional information by contacting Tractive Technology, LLC at the address printed on the card). Please attach your name, address, telephone number, and a copy of the bill of sale as proof of date of original retail purchase, as well as a detailed description of the problem for which service is requested. Prior to returning the product, you must obtain from Tractive Technology, LLC a Return Merchandise Authorization Number (RMA#). You are responsible for packing the product to be returned. If the repairs are covered by the Limited Warranty and if the product was properly shipped to Tractive Technology, LLC, Tractive Technology, LLC will pay the return shipping charges. This warranty applies only to AUTO-BLiP product manufactured by Tractive Technology, LLC that can be identified by the "AUTO-BLiP" trademark, trade name, or logo affixed to them. This warranty does not cover damage resulting from an accident, misuse, abuse, or neglect and/or damage during any type of transportation resulting from improper packaging; damage to any product which has been altered in any fashion, including the alteration or removal of any Tractive Technology, LLC serial number; damage resulting from causes other than product defects, including and not by way of limitation, lack of technical skill, competence, or experience of the user, and/or failure to use the product in accordance with the instructions provided in the User's Manual; and service performance by an unauthorized person or entity. Any implied warranties including fitness for use and merchantability are limited in duration to the period of the expressed warranty set forth above. The remedies provided under this warranty are exclusive and in lieu of all others. Tractive Technology, LLC hereby expressly disclaims liability and shall not be responsible for incidental, consequential and contingent damages or any kind of nature, including, without limitation: damages to persons or property, whether a claim for such damages is based upon warranty, contract, tort or otherwise; damages to persons or property, whether a claim for such damages is based upon warranty, contract, tort or otherwise; damages due to or arising out of the loss of date; or lost of profits. Tractive Technology, LLC shall not be responsible for any damages caused by the presence of error or omission in any of its manuals, instructions or related materials.

For warranty claims
contact:

Latitude 305, LLC
(713)289-4015

or email:
al@auto-blip.com